

SMW

Twin-Wall, Insulated
Stainless Steel
Multi-Fuel
Chimney System

DIAMETER RANGE
127mm-355mm (5"-14")

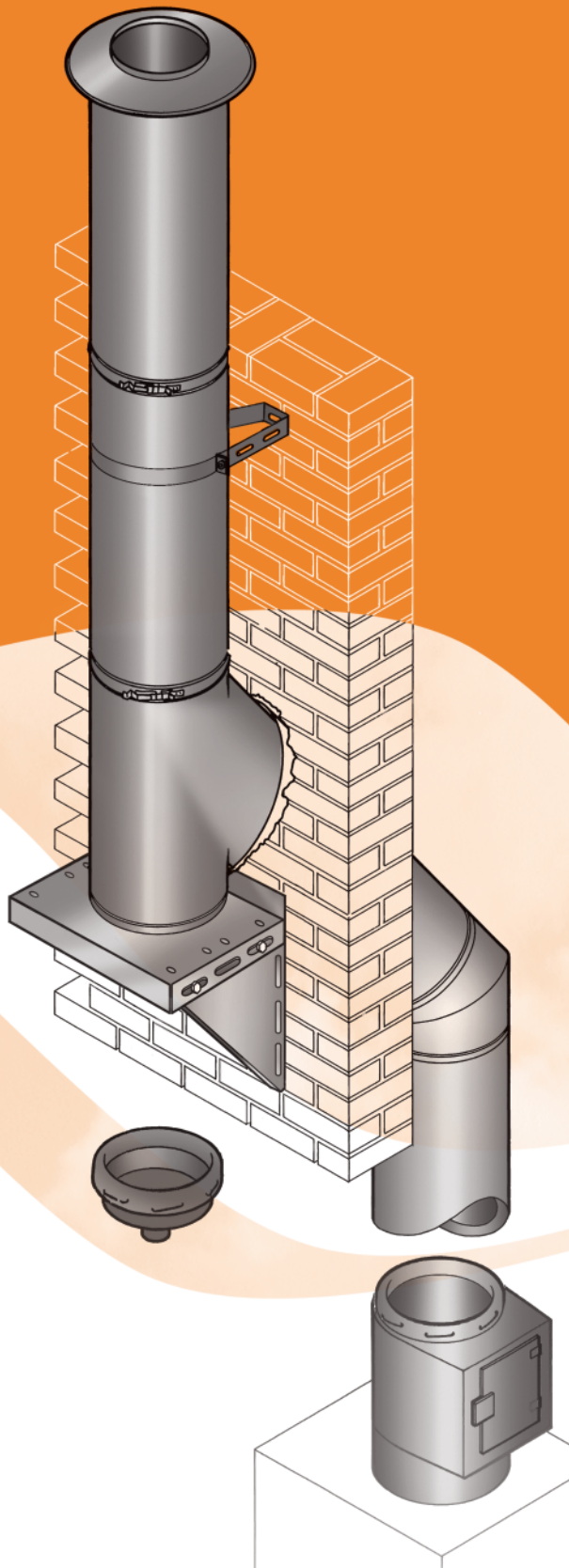

Product Information

The SMW Chimney Systems is a high quality prefabricated stainless steel insulated chimney system designed for solid and multi-fuel combustion equipment operating under natural draught and non-condensing conditions.

Multi Fuel Chimney System Twin Wall, Insulated Stainless Steel

Introduction

SMW is a prefabricated twin wall insulated chimney system and has been designed specifically to be used on solid, multi-fuel, gas and oil fired combustion equipment, operating under negative natural draught conditions. Under no circumstances should SMW be used on appliances that generate excessive condensation such as condensing appliances or where the chimney system has been designed to operate under positive pressure conditions. For applications requiring condensate and pressure resistance our Nova SM product should be used.

The SMW product is manufactured to the highest quality and is CE Marked to BS EN 1856-1, suitable for appliance with flue gas temperatures up to 450°C (550°C Intermittent).

The system consists of straight pipe lengths and associated fittings, which are constructed entirely from Austenitic stainless steel and have a 25mm insulated annulus. The external casing is weatherproof and supports the structural load, while the inner liner is manufactured from a high grade 316L stainless steel, offering excellent protection from the often corrosive products of combustion and is free to expand or contract as the flue gas temperatures change.

SMW can be used either internally or externally. The relatively low external wall temperature permits installation with only a 50mm air gap clearance to combustible material. The distance to combustible material is related to the thermal testing procedure as defined in BS EN 1856-1 / BS EN 1859.

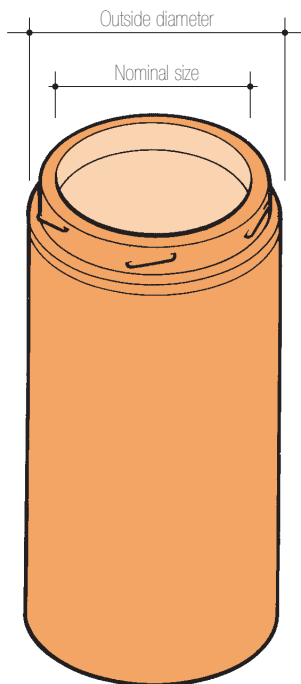

SMW Product Designation To BS EN 1856-1

Cert. No: 0086-CPD-496040	SMW	BS EN 1856-1	T450	N1	D	Vm	L50040	G(50)
Standard Number								
Temperature Level < = 450°C								
Pressure Level								
Condense Resistance D = Dry W = Wet								
Corrosion Resistance								
Material Specification Liner = Grade 316L S/S Liner Thickness 0.4mm								
Sootfire Resistance G = Yes O = No (50) = Distance to combustible material								



Nominal size (internal diameter)	Outside diameter	Cross-sectional area
127mm (5in)	175mm (7in)	12 668mm ² (20in ²)
152mm (6in)	200mm (8in)	18 146mm ² (28in ²)
178mm (7in)	230mm (9in)	24 885mm ² (38in ²)
203mm (8in)	255mm (10in)	32 365mm ² (50in ²)
254mm (10in)	303mm (12in)	50 670mm ² (79in ²)
304mm (12in)	353mm (14in)	72 583mm ² (113in ²)
355mm (14in)	404mm (16in)	19 980mm ² (154in ²)

Note that the metric nominal sizes have been converted from their true imperial sizes and rounded to the nearest equivalent.

Description

Composition and manufacture

All lengths and fittings are twin-walled with a 25mm cavity. The outer case is attached to both the male and female couplers, while the inner liner is attached only to the upper male coupler, allowing the liner to expand or contract as the flue gas temperature varies without affecting the structural performance of the outer and removing the need for expansion components such as bellows etc. The SMW product utilises a mineral wool insulating medium providing an optimum and carefully controlled density of 240Kg/m², which in addition to providing safe operation at high temperature, also maintains a relatively high flue gas temperature throughout the chimney length, enabling the provision of a rapidly established and stable draught. Lengths and fittings utilise a rapid one-eighth turn twist action locking system at the joint, allowing simple and rapid installation of the product. A toggle clip locking band must then be fitted to finish each joint.

Application

SMW is primarily designed for use on domestic and commercial solid, multi-fuel, oil and gas appliances such as stoves, boilers and heaters operating under dry and negative draught conditions where the flue gas temperature will not exceed 450°C.

The chimney system should be installed in accordance with the requirement of BS EN 15287-1: 2007 "Chimneys - Design, installation and commissioning of chimneys" and, depending on where used in the United Kingdom, the requirements of: Document "J" of the Building Regulations, Section "F" of the Building Standards (Scotland), Section "L" of the Building Regulations (Northern Ireland). For gas fired appliances of rated input not exceeding 60kW, reference should also be made to BS 5440 Part 1. The SMW product is CE Marked to BS EN 1856-1 to the designation detailed on page 2. SMW is also manufactured under a Quality Assurance Scheme certificate No. FM557622 administered by British Standards in accordance with BS EN ISO9001:2008. CE Certificate No. 0086-CPD-496040. SMW is also listed by HETAS as an approved chimney for solid fuel.

Installation

Installation instructions are on pages 10 and 11 and are provided with all support components. These should be consulted to accurately determine the components that are required to enable any installation to be correctly assembled.

Jointing

All lengths and fittings are designed to be installed with the male coupling uppermost. Joints are achieved simply by placing the female coupling over the male coupling and making a one-eighth turn. A Locking Band must be used to secure every joint and to ensure a firm connection.

Connection to the appliance outlet

Both standard, cast iron and increaser adaptors are available to facilitate connection to the heating appliance in accordance with Building Regulations.

Supports

The weight of the chimney may be carried by a number of components according to whether the chimney is installed internally or externally, and whether it is supported by the roof, ceiling, floor or external wall. These components include the Wall Support, Ceiling Support, Roof Support, Telescopic Floor Support and Ventilated Ceiling Support. Lateral stability is provided by Wall Bands, Bracing Brackets or Guy Wire Brackets.

Supporting free-standing chimneys:

Irrespective of roof configuration, where the chimney exceeds 1.5m beyond the last support it must be braced with steel bracing rods or preferably angle iron. Guy wires should only be used where alternatives are not possible. In either case, a Guy Wire Fixing Bracket should be used and secured above a Locking Band as close to the joint as possible. Where the chimney is supported by a mast consult SFL.

Roof support

The Roof Support is designed for supporting the chimney on the roof joists and is provided with adjustable gimbal plates. Bracing Brackets should be used in the roof space to restrain movement of the chimney due to wind forces on the chimney above the roof.

Load bearing performance

The weight of the chimney supported depends on the support components employed: the Table B on page 11 provides support details.

Weight characteristics

The table below indicates average weight of each diameter per metre run installed, excluding support components.

	127mm	152mm	178mm	203mm
SMW	6.7kg	8.2kg	9.7kg	11.2kg
	254mm	304mm	355mm	
SMW	14.5kg	17.0kg	19.5kg	

Clearance

The relatively low external casing temperature experienced in normal operation permits installation with only 50mm air gap clearance to combustible material. However, where the SMW Chimney passes through a combustible floor or ceiling and serves a solid / multi-fuel or oil fired appliance where the flue gas temperature exceeds 250°C, a Ventilated Firestop and Ventilated Ceiling Support **MUST** be used to maintain the 50mm clearance and act as a firestop.

Lengths of chimney

Standard lengths of 1000mm, 500mm, 300mm and 120mm as well as two adjustable lengths are available. Please see individual component tables for further information.

Restrictions on elbows

15°, 30° and 45° Insulated Elbows are available for use where it is not possible to construct a vertical chimney. Building Regulations dictate that no part of a chimney should form an angle greater than 45° from the vertical, except where it may be necessary to use a very short horizontal section of flue to connect the chimney to a back outlet appliance. Additional restrictions also apply on angles. See paragraph 8 of the Installation Instruction on page 10.

Floor and ceiling penetrations

Where the chimney penetrates a combustible floor or ceiling, a 50mm air gap clearance must be maintained, and the opening fire-stopped. Where SMW is used for Solid and multi-fuel applications and where the flue gas temperature is greater than 250°C, the ventilated support and fire stop components must be used as detailed on pages 7 & 8. Floor apertures **MUST** be lined with 1/2 hour fire rated board. For oil and gas applications where the flue gas temperature is below 250°C or where the chimney passes through a non-combustible floor the Ceiling Support and Firestop Spacer can be used.

The combination of lengths used must be such that no joint occurs within the thickness of any floor or ceiling construction, and where connected to a flue pipe serving solid fuel, multi-fuel or oil fired appliances, the chimney must project at least 150mm below the ceiling before the connection to the flue pipe is made.

SFL Patented Intumescent Ceiling Support

The Ventilated Ceiling Support utilises a patented intumescent matrix. In the event of a fire in the appliance room, the intumescent matrix rapidly expands to close off the ventilation slots and form a fireproof barrier, stopping the potential spread of fire to the first floor area.

Fire Rating

The SMW product in accordance with the stability and integrity criteria of BS 476: Part 20 is fire rated for a period of 120 minutes.

Roof penetrations

Flat and Adjustable Flashings are available to provide the appropriate weather cover where a chimney penetrates the roof. Both types are fabricated from sheet aluminium.

The flat flashing is suitable for flat or nearly-flat roofs. The Adjustable Flashing is available in two types, for low or steeper pitched roofs. Both types of Adjustable Flashing are available with the flashing base constructed from malleable alloy for use with heavily-contoured roof tiles (to special order). Storm Collars are supplied with sealant and should be placed over the pipe immediately above the flashing. They are screw-clamped over the pipe and must be sealed to its outer wall with a waterproofing sealing compound. Alternatively, the Seldek Flashing system, manufactured in EPDM is available (see separate literature).

Terminations

Four types of termination are available. All have a female coupling and are fixed to the top of the chimney length and secured with a Locking Band. The insulated Top Stub provides a neat finish to the top of the chimney where a Rain Cap is not required. The Rain Cap is a domed stainless steel cap. The Round Top allows rapid exhaust of combustion products and its integral skirt deflects the wind. For gas fired appliances, the Gas Terminal is available for diameters 127mm to 350mm.

Product handling

The products are relatively easy to handle, but care should be taken when holding, fitting or assembling any part of the system. Users are advised to take suitable precautions, gloves etc., to avoid injury on any sharp exposed edges.

Design Information

SFL offers a comprehensive chimney sizing and design service to the trade and distribute through a geographic network of specialist distributors and national merchants. SFL cannot accept responsibility for any installation or application, which seeks to combine the SMW chimney with any other form of chimney construction.

Product Warranty

The SFL SMW chimney system is covered by a manufacturing defects warranty for a period of 10 years, subject to written conditions, copies of which are available on request.

Notes on Life Expectancy

Those components within the SMW range which are fabricated from only a single skin, can be vulnerable when exposed to the products of combustion from solid fuel appliances. In the majority of cases, an open-ended terminal better suits appliance performance, but it is acknowledged that on occasions, other types of terminal from the SMW range have to be used to reduce rain entry. The Condensate Collector and the Locking Plug when used with solid fuel are also vulnerable to flue gas by-products, particularly if the chimney is not regularly maintained and cleaned.

Such components are considered sacrificial and their life expectancy will vary dependant on application, location, maintenance and fuel usage. For that reason, the Rain Cap, Round Top, Condensate Collector and Locking Plug are not covered by any warranty other than for a twelve month period against defective manufacture.

It should also be noted that chemically contaminated combustion air will also affect the durability of the product as will the use of chemical chimney cleaners. Typical examples of contaminated combustion air has been seen in de-greasing plants and dry-cleaning companies

Where used on solid fuel, care should be taken to ensure that only high quality fuel is used. SFL do not recommend fuels such as petroleum coke or other fuels containing a blend of petroleum coke. Also some smokeless fuels contain halogens that are released when burned, forming Hydrochloric and Hydrofluoric Acids. These fuels can lead to premature failure of the chimney system through corrosion. Before burning any fuel, SFL would suggest that written confirmation is obtained to ensure that the fuel is halogen free.

Only HETAS Approved fuels should be used with SFL products.

Freshly cut firewood can contain up to 50% moisture, provision must be made to allow the wood to season so that the moisture content is reduced to around 20%. This must be done in a dry environment and can take up to 8 months. Green wood can lead to products like creosote being deposited on the chimney liner and could lead to a chimney fire occurring.

Adequate provision should be made for inspecting and cleaning the chimney system. This is particularly important for solid fuel applications.

SFL recommends that chimneys serving solid fuel appliances are swept at least twice a year. If the appliance is allowed to slumber, it should be run at full fire for at least 30 minutes per day, to reduce the build up of corrosive substances. Under no circumstances should chemical cleaning agents be used in the chimney.

It is recommended where the SMW product is installed near coastal locations that any external part of the chimney is protected from the salt environment by means of a suitable protective coating over the external surface.

Individual components

Lengths

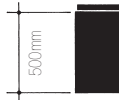

Straight lengths

Fixed straight lengths are available in four lengths: 120mm, 300mm, 500mm and 1000mm. Actual length of component is 32mm greater. Please note that no lengths are provided with Locking Bands.

Size (mm)	Code Nos.			
	120	300	500	1000
127	0110605	0141105	0141005	0140905
152	0110606	0141106	0141006	0140906
178	0110607	0141107	0141007	0140907
203	0210608	0241108	0241008	0240908
254	0210610	0241110	0241010	0240910
304	0210612	0241112	0241012	0240912
355	0210614	0241114	0241014	0240914

Adjustable Lengths

A telescopic section designed to provide small increments in lengths between two fixed points. Two versions are available to provide maximum flexibility, ie, INTERMEDIATE (200mm-325mm adjustment) and LONG (350mm-530mm adjustment). The components are NOT load-bearing. Self-tapping screws are provided to secure the overlap once the required length has been determined. Because the component's application, and therefore performance, cannot be accurately controlled, it should be used internally and, in any event, never positioned so that the external skin is nearer than 305mm from any combustible material.

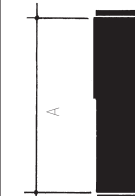

A (mm)
INTERMED 200 - 325
LONG 350 - 530

Size	Code Nos.	
	INTERMED	LONG
127mm	0144005	0141205
152mm	0144006	0141206
178mm	0144007	0141207
203mm	0244008	0241208
254mm	0244010	0241210
304mm	0244012	0241212
355mm	0244014	0241214

Starter Length

Offers an aesthetic solution to facilitate connection to a single wall connecting pipe.

Size	Dimensions		Code No.
	A		
127mm	125		0140405
152mm	150		0140406
178mm	175		0140407
203mm	200		0240408

For painted back version add 'B' to the end of the part number.

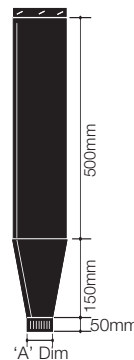



Locking Band

Used at all joints between chimney lengths or lengths and fittings.

Size	Code No.
127mm	0108605
152mm	0108606
178mm	0108607
203mm	0208608
254mm	0208610
304mm	0208611
355mm	0208614

Fittings

90° Equal Tee

Used at base of vertical chimney. Can be used on the base or branch to provide access.

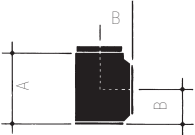

Size	Dimensions		Code No.
	A	B	
127mm	298	149	0114305
152mm	324	162	0114306
178mm	349	175	0114307
203mm	375	187	0214308
254mm	425	213	0214310
304mm	476	238	0214312
355mm	526	263	0214314

135° Tee

Used at base of vertical chimney. Can be used on the base or branch to provide access.

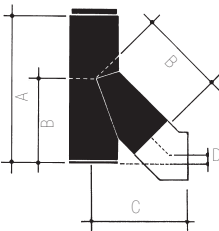

Dimensions "C" & "D" apply where Tee is used with 45° Elbow

Size	Dimensions				Code No.
	A	B	C	D	
127mm	500	311	368	30	0141305
152mm	500	341	398	35	0141306
178mm	500	378	433	42	0141307
203mm	1000	408	463	47	0241308
254mm	1000	466	522	57	0241310
304mm	1000	526	584	66	0241312
355mm	1000	588	645	77	0241314

Wall Sleeve

Must be used where 135° Tee is used to pass the chimney through an external wall. The sleeve component provides, in effect, an uninterrupted run through the wall.

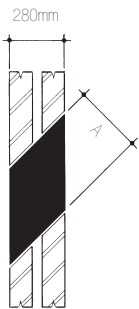

Size	Dimensions	Code No.
	A	
127mm	200	0107105
152mm	225	0107106
178mm	256	0107107
203mm	280	0207108
254mm	328	0207110
304mm	378	0207112
355mm	429	0207114



Condensate Collector

Provides a removable trap for condensation and soot/debris under an Insulated Tee and is locked into the Female Coupler under the Anchor Plate. Easily removed to provide cleaning access. Uninsulated and non-Load bearing, it incorporates a stainless steel drain tube and cap having a 25mm bore and a 1" BSP external thread. This component must be secured with a Locking Band.

Size	Code No.
127mm	0153205
152mm	0153206
178mm	0153207
203mm	0253208
254mm	0253210
304mm	0253212
355mm	0253214

Locking Plug

Used to seal and provide access on a female connection of a length or fitting.

Size	Code No.
127mm	0119105
152mm	0119106
178mm	0119107
203mm	0219108
254mm	0219110
304mm	0219112
355mm	0219114

15° Elbow

Used to provide offsets or bends.

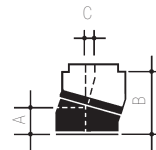

Size	Dimensions			Code No.
	A	B	C	
127mm	87	342	45	0131405
152mm	92	362	48	0131406
178mm	97	381	50	0131407
203mm	102	401	53	0231408
254mm	113	447	58	0231410
304mm	124	487	64	0231412
355mm	134	527	69	0231414

30° Elbow

Provides a 30° bend; or, by using two components, a 60° or variable offset bend can be obtained.

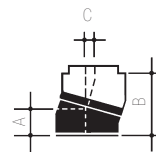

Size	Dimensions			Code No.
	A	B	C	
127mm	87	325	87	0132305
152mm	92	343	92	0132306
178mm	97	362	97	0132307
203mm	102	381	102	0232308
254mm	113	422	113	0232310
304mm	124	463	124	0232312
355mm	134	500	134	0232314

45° Elbow

Provides a 45° bend; or, by using two components, a 90° or variable offset bend can be obtained.

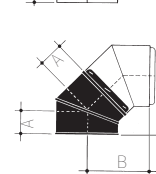
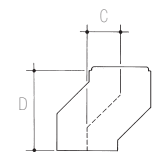

Size	Dimensions				Code No.
	A	B	C*	D	
127mm	87	210	123	297	0132205
152mm	92	222	130	314	0132206
178mm	97	234	137	331	0132207
203mm	102	246	144	348	0232208
254mm	113	273	160	386	0232210
304mm	124	299	175	423	0232212
355mm	134	324	190	458	0232214

* maximum offset

Adaptor

Used to connect appliance flue outlets or vertical or horizontal single-wall flues to insulated chimneys.



Size	Dimensions A (I.D.)	Code No.
127mm	128	0119405
152mm	153	0119406
178mm	179	0119407
203mm	204	0219408
254mm	254	0219410
304mm	305	0219412
355mm	356	0219414

Adaptor for Cast-Iron Pipe

Used to connect boiler flue outlets or cast-iron or mild-steel flue pipes to insulated chimney lengths. The crimped inner lining fits inside the pipe or outlet and, where the outer casing fits outside the flue or outlet, it should be caulked with a fire cement compound.

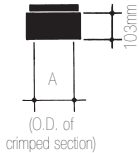

Size	Dimensions A (I.D.)	Code No.
127mm	114	0119505
152mm	140	0119506
178mm	165	0119507
203mm	190	0219508
254mm	241	0219510
304mm	292	0219512
355mm	343	0219514

Increaser Adaptor

Used to increase the appliance spigot to the next size chimney diameter.

Size	Code No.
100 - 125 SMW	0129705
125 - 150 SMW	0119706

Inspection Length

Used to provide access for inspection or cleaning. A recessed square catch prevents unauthorised use. Access may also be provided to the chimney using a 90° Insulated Tee with a Locking Plug in the branch.

Where used with solid, multi-fuel or oil-fired appliances, a 150mm air-gap clearance must be maintained from the outer surface of this component to any combustible material.

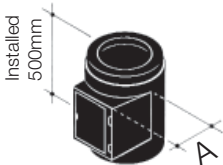

Size	Dimensions A	Code No.	Door Size (140 x 200mm)
127mm	148	0141805	
152mm	160	0141806	
178mm	175	0141807	
203mm	188	0241808	
254mm	212	0241810	
304mm	237	0241812	
355mm	263	0241814	

Flue Draught Stabiliser

Designed to be used with any SFL Flue system where excessive draught is likely to create combustion problems. Where used with the SMW Chimney System, the Stabiliser should be applied with the Appliance Adaptor, Code No. 194, (in turn located onto the 90° Tee branch).

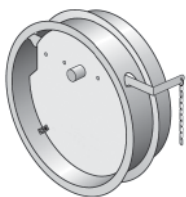

Separate detail sheet and instruction available on request

To fit flue Ø	Code No.
127mm	3192005
150mm	3192006
175mm	3192007
203mm	3192008
250mm	3192010
300mm	3192012
350mm	3192014

Flexible Liner Adaptor

Used where SMW connects an appliance to an existing chimney which is to be lined. Lower end of this connects to standard product. The upper end incorporates a socket/stub designed to accommodate flexible chimney liner.

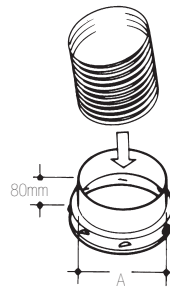

Size	Dimension A	Code No.
127mm	134	0150105
152mm	161	0150106
178mm	187	0150107
203mm	218	0250108
254mm	263	0250110
304mm	313	0250112
355mm	364	0250114

Modular Tees

Designed for use with modular boiler installations and other applications where a manifold or horizontal header is required. Can be manufactured to order in any standard pipe size; number, size and orientation of pipe sizes required.

Trim Plate Collar

Polished stainless steel circular collar with a 100mm wide flange to provide a neat finish at the ceiling or where exposed internal chimneys meet the appliance.

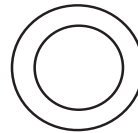

Size	Code No.
127mm	0108505
152mm	0108506
178mm	0108507
203mm	0208508
254mm	0208510
304mm	0208512
355mm	0208514

Flashings & Terminals

Top Stub

Secured with a Locking Band.

Size	Code No.
127mm	0117305
152mm	0117306
178mm	0117307
203mm	0217308
254mm	0217310
304mm	0217312
355mm	0217314

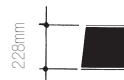

Rain Cap

Secured with a Locking Band.

Size	Dimensions		Code No.
	A	B	
127mm	127	254	0107405
152mm	143	305	0107406
178mm	165	356	0107407
203mm	183	406	0207408
254mm	229	508	0207410
304mm	273	610	0207412
355mm	319	712	0207414

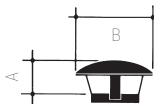

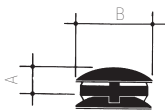

Round Top

Secured with a Locking Band.

Size	Dimensions		Code No.
	A	B	
127mm	96	254	0107505
152mm	110	305	0107506
178mm	127	356	0107507
203mm	144	406	0207508
254mm	179	508	0207510
304mm	214	610	0207512
355mm	248	712	0207514

Gas Terminal

This component is for use where the system is used on gas fired appliances Secure with a Locking Band.

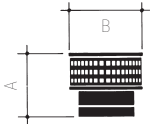

Size	Dimensions		Code No.
	A	B	
127mm	93	236	0152405
152mm	93	267	0152406
178mm	220	295	0152407
203mm	220	322	0252408
254mm	220	370	0252410
304mm	220	422	0252412
355mm	220	472	0252414

Flat Flashing

For flat or nearly-flat roofs.

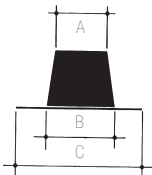

Size	Dimensions			Code No.
	A	B	C*	
127mm	190	280	495	70000007
152mm	210	300	495	70000009
178mm	240	330	610	70000010
203mm	260	350	610	70000011
250mm	310	400	610	70000012
300mm	360	450	660	70000013
350mm	410	500	762	70000014

* base is square (C x C)

5°-30° Adjustable Flashing

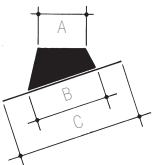

Size	Dimensions			Code No.
	A	B	C*	
127mm	190	281	495	70053007
152mm	210	304	508	70053009
175mm	240	335	550	70053010
203mm	260	361	578	70053011
250mm	310	419	610	70053012
300mm	360	476	678	70053013
350mm	410	533	762	70053014

* base is square (C x C)

32°-45° Adjustable Flashing

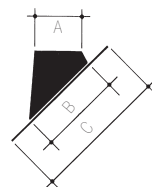

Size	Dimensions			Code No.
	A	B	C*	
127mm	190	375	578	70324507
152mm	210	403	610	70324509
175mm	240	428	650	70324510
203mm	260	475	678	70324511
250mm	310	546	737	70324512
300mm	360	617	820	70324513
350mm	410	689	889	70324514

*base is square (C x C)

**The degree of malleability is limited. Excessively corrugated or profiled roofs could exceed the limitations of the malleable flashings.

Alternatively, the Seldek range of flashings, manufactured in EPDM material are available. See separate brochure for details.

Storm Collar

Used as a weathering over flashing and supplied with sealant.

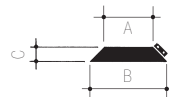

Size	Dimensions			Code No.
	A	B	C*	
127mm	177	280	70	70123407
152mm	202	301	70	70123409
175mm	227	330	70	70123410
203mm	252	351	70	70123411
250mm	302	401	70	70123412
300mm	352	451	70	70123413
350mm	402	501	70	70123414

Support Components (Gas & Oil <250°C)

The following components MUST be used where SMW is used on gas or oil fired appliances where the flue gas temperatures do not exceed 250°C and/or where the chimney system penetrates a non-combustible floor.

Ceiling Support

Provides a 50mm air gap clearance to a penetrated floor or ceiling and is only used where SMW penetrates a non-combustible floor, and/or serves a gas or oil fired appliance where flue gas temperatures do not exceed 250°C.

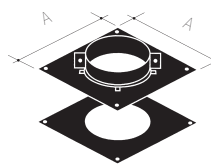

Firestop Spacer

Used to provide location, fire and dust stopping where SMW is used through non-combustible and combustible floors when serving gas or oil fired appliances ONLY with a flue gas temperature not exceeding 250°C. These components are supplied singly but are usually used in pairs and are not Load bearing.

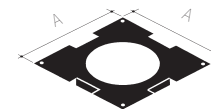

Size	Dimensions A	Code No.
127mm	330	0108705
152mm	355	0108706
178mm	381	0108707
203mm	406	0208708
254mm	457	0208710
304mm	507	0208712
355mm	558	0208714

Support Components (Solid Fuel/Oil >250°C)

The following components MUST be used where SMW is used on solid fuel and oil fired appliances where flue gas temperature exceeds 250°C and/or where the chimney system penetrates a combustible floor.

Ventilated Fire Stop

This component MUST always be used where SMW is used internally on Solid Fuel or Oil fired appliances producing flue gas temperatures exceeding 250°C and passes through combustible floors where the sections below the floor penetration are enclosed within a compartment.

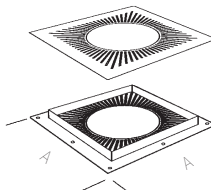

Size	Dimensions A	Code No.
127mm	379	0188705
152mm	399	0188706
178mm	429	0188707
203mm	453	0288708

Ventilated Ceiling Support

This component MUST always be used where SMW is used internally on solid fuel or oil fired appliances producing flue gas temperatures exceeding 250°C and passes through the first combustible floor above the heating appliance. Fitted with an intumescent matrix.

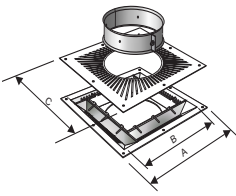

Size	Dimensions		Code No.
	A	B	
127mm	379		0172705
152mm	399		0172706
178mm	429		0172707
203mm	453		0272708

For painted add ZB (Black) or ZW (White) after the part number.
The above ventilated components are of patented design as
UK Patent 2388651.

Fixings & Supports

Bracing Bracket

Used to provide lateral stability to a chimney passing through the roof space.

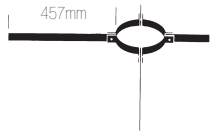

Size	Code No.
127mm	0109805
152mm	0109806
178mm	0109807
203mm	0209808
254mm	0209810
304mm	0209812
355mm	0209814

Universal Wall bands

Used for lateral support with no more than 3.0m externally and 3.5m internally between centres. The galvanised wall band is intended for internal applications only, whereas the stainless steel version can be used for both internal and external applications.

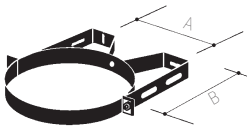

Size	Dimensions		Code No.
	A*	B	
127mm	138	136	3115155
152mm	163	148	3115205
178mm	188	161	3115234
203mm	213	173	3115255
254mm	271	200	3115305
304mm	321	225	3115355
355mm	371	450	3115405

Size	Dimensions		Code No.
	A*	B	
127mm	138	136	3116155
152mm	163	148	3116205
178mm	188	161	3116234
203mm	213	173	3116255
254mm	271	200	3116305
304mm	321	225	3116355
355mm	371	450	3116405

*fixing centres

Guy Wire Bracket

Wires are not provided. Rigid Stays are preferred. Structural calculations should be made for each application. See installation instructions.



Size	Code No.
127mm	0109205
152mm	0109206
178mm	0109207
203mm	0209208
254mm	0209210
304mm	0209212
355mm	0209214

Roof Support

Provided with adjustable gimbal plates to permit a chimney to be supported on roof joists, trussed rafters etc. Maximum suspended chimney length supported is 6m and maximum total length supported is 9m.

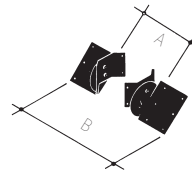

Size	Dimensions		Code No.
	A*	B	
127mm	280	490	0102900
152mm	304	515	0102900
178mm	330	545	0102900
203mm	356	570	0102900
254mm	406	618	0102900
304mm	456	688	0102900
355mm	506	719	0102900

*Minimum distance between roof trusses

Telescopic Floor Support

Used to support chimney at floor level.

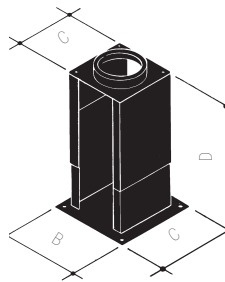

Size	Dimensions				Code No.
	A	B	C	D	
127mm	246	340	290	300-550	0102605
152mm	271	365	315	300-550	0102606
178mm	296	390	340	300-550	0102607
203mm	322	416	366	300-550	0202608
254mm	371	465	415	300-550	0202610
304mm	421	515	465	300-550	0202612
355mm	471	565	515	300-550	0202614

Mounting Plate for Precast Chamber or Lintel

Designed to be used when connecting SMW chimney to a Lintel.

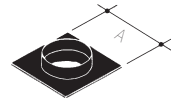

Size	Dimensions		Code No.
	A	B	
127mm	210		0152705
152mm	235		0152706
178mm	261		0152707
203mm	286		0252708
254mm	337		0252710
304mm	387		0252712
355mm	438		0252714

Adjustable Wall Support

Designed to be internally or externally applied to provide either initial or intermediate support for the chimney. Maximum supported chimney lengths are detailed on page 11.

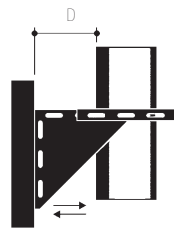

Size	Code Number	
	Stainless Steel	Galvanised
127mm	0151705	0199805
152mm	0151706	0199806
178mm	0151707	0199807
203mm	0251708	0299808
254mm	0251710	0299810
304mm	0251712	0299812
355mm	0251714	0299814

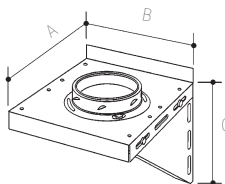

Size	Dimensions			
	A	B	C	D
127mm	282	311	279	150
152mm	302	331	299	150
178mm	331	360	328	200
203mm	355	384	352	200
254mm	403	432	399	220
304mm	453	482	449	267
355mm	504	533	500	293

Typical Applications

Where the chimney passes through the roof space, it is essential that it is adequately supported by bracing to roof timbers. If there is a chimney run of more than 1.5m from the Ceiling Support to the Roof Support, use a Bracing Bracket and rigid stays for such an application. Also provision must be made to ensure that no accidental placement of combustible product can occur within 50mm of the external casing of the chimney. For example a mesh or screen around the lower part of the chimney directly above penetration would be acceptable.

It is a Building Regulation requirement that any prefabricated chimney arrangement in an accessible roof must be protected such that combustible materials cannot come into contact with the outer skin of the chimney. A minimum air gap clearance of 50mm can be maintained using cladding or a wire frame.

Chimney joints must not be positioned in the thickness of floor or ceiling joist spaces or within 150mm of floor/ceiling.

The fire resistant enclosure must maintain a 50mm clearance from any combustible material, this also applies to any combustible material within the enclosure (See instructions 5 & 7).

The chimney must project 150mm below ceiling level before flue pipe connection is made. It is very important that if a spigotted flue pipe is used, the lower end of the Adaptor does not rest on the shelf of the spigot. Allow at least 15mm for expansion of the flue pipe, and whatever the configuration, seal the joint with fire cement and fibre rope or suitable alternatives. Single wall flue pipes should maintain a distance of $3 \times OD$ to any adjacent combustible surface.

For solid fuel back or side flue outlet, the maximum legally permitted length of horizontal chimney or flue pipe is 150mm.

Fig. 4

No more than ONE offset in the chimney, (not including the connection to the appliance). The length of chimney between Elbows MUST NOT exceed 20% of the total chimney length.

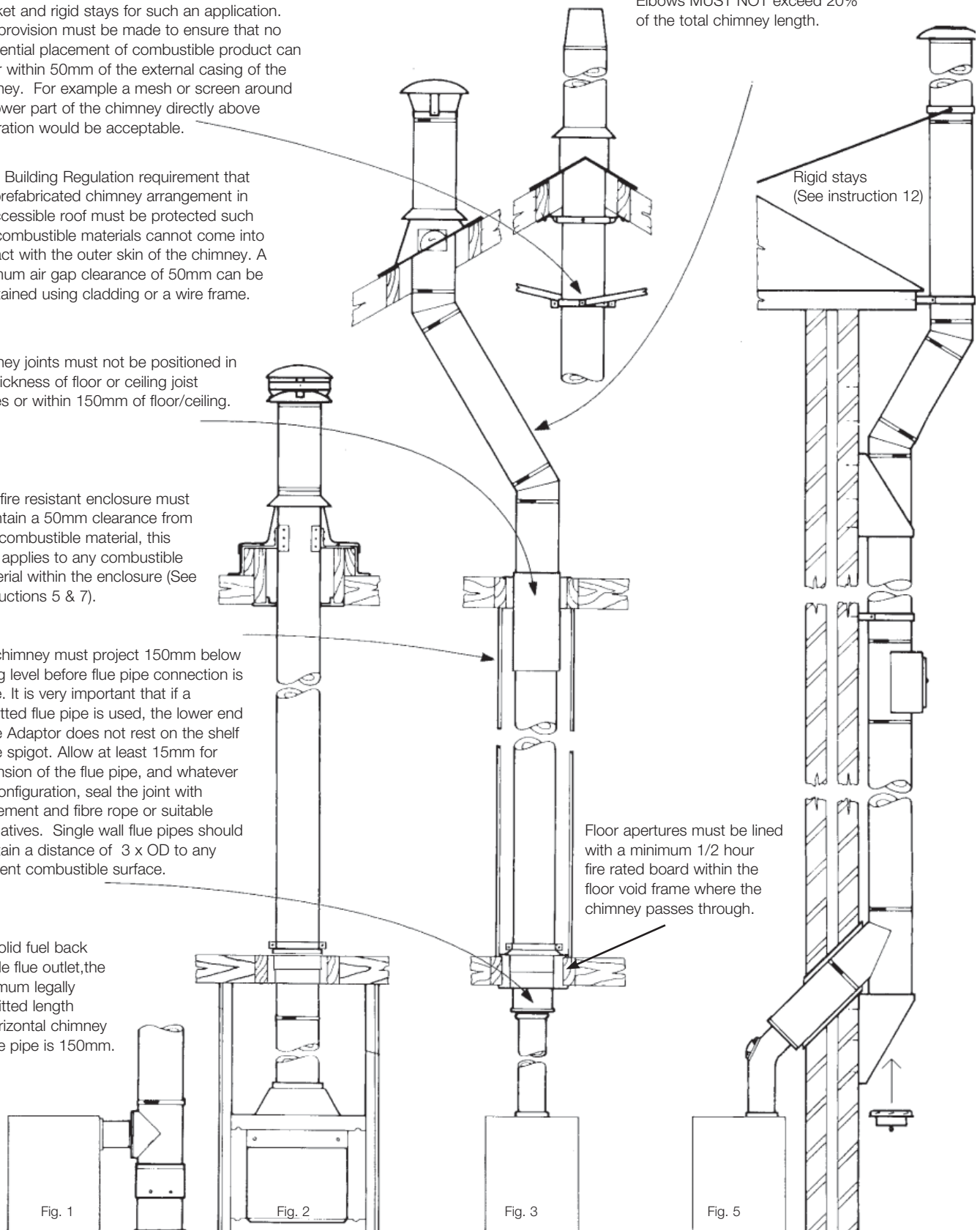

Apply these illustrations with the instructions on the next page.

Installation instructions

- 1 It is important to consult with the Building Regulations and, where the equipment served exceeds 150kW, the Clean Air Memorandum if appropriate.
- 2 To conform with Building Regulations, ensure that either an Inspection Length or an Insulated 90° or 135° Tee is used to provide easy access to the chimney for inspection and cleaning (unless such inspection and cleaning can be achieved through the appliance).
- 3 The internal diameter of the chimney must conform to the requirements of the heating appliance manufacturer's instructions and should not, under any circumstances, be less than the diameter of the appliance outlet. The height of the chimney will depend on the building structure with which it is used. However, not less than 4.5 metres chimney height from the top of the appliance is considered the minimum height for solid fuel appliance use. In any event, SFL have available Technical Data which provides chimney sizing criteria for any configuration.
- 4 Each chimney section and associated fitting shall be used as manufactured for assembly on site without any alteration or cutting. Sections and components are easily secured together with an eighth of a turn twist-lock which provides a sturdy and neat joint. Make sure that the elements are installed the right way up, with the male coupler uppermost. Once assembled, Locking Bands must be fitted to every joint. No special tools or sealing compounds are required.
- 5 Where used with SOLID FUEL or OIL appliances producing flue gas temperatures exceeding 250°C, the clearances at floor/ceiling joists must be established using the Ventilated Ceiling Support and the Ventilated Firestop.

All of these components incorporate spacers which are designed to provide a minimum 50mm air gap clearance from combustibles. This distance MUST be maintained elsewhere in the system between the outer case of the chimney and any combustible materials. Do not place any additional insulation material around any part of the chimney, and in all cases, the system must be designed so that no joints between chimney elements occur within the thickness of a floor space. Where used with GAS appliances, a minimum air gap clearance must be maintained between combustibles and the outside skin. For installation and access reasons, the support components provide a 50mm clearance to adjacent structure, but this can be reduced to 25mm if required.
- 6 Joints between floors. The selection of chimney elements should be made so that no joints occur within the thickness of a floor space.
- 7 Where serving Solid Fuel or Oil appliances, any part of the chimney which passes through any room other than that in which the appliance using the chimney is situated, should be protected to prevent both damage and the accidental location of combustible materials against the outer skin. It is a Building Regulation requirement that ANY factory made insulated chimney should be enclosed where passing through a cupboard, storage space or habitable space. Any such enclosure must be constructed of materials and applied in such a way that they can be considered as providing access to the chimney. In the case of SMW, the 50mm air gap clearance applies.
- 8 No part of the system should be constructed at an angle greater than 45° from the vertical. The only permitted exception is where it is necessary to use an angle of 90° to make the connection to an appliance, which can be direct or with the use of a suitable flue pipe. The latter arrangement can be constructed using the 90° Tee as illustrated in these instructions. Where a change of direction or offset is required, 15°, 30° and 45° Elbows should be used within the limitations earlier mentioned. NOTE. Building Regulations will not permit more than ONE offset in any chimney run, (ie 2 Elbows). However, that excludes any Elbows used to make the connection to the appliance. Where an offset is used, the length of chimney between two elbows MUST NOT exceed 20% of the total length of the chimney.
- 9 The chimney must be adequately supported with the system support elements. Where externally used, the chimney must be supported on a wall or mast. (For latter applications, seek further details from SFL). The external support components must be used at intervals depending on the load-bearing criteria quoted in Table B. Wall Bands are not load-bearing and should be provided at intervals not exceeding 3.0 metres external and 3.5 metres internal for lateral stability only. Where used externally the stainless steel Wall Band should be used. All support components, except Wall Bands, are provided with their own installation instructions.
- 10 Where an external installation requires the chimney to offset past a roof overhang, Elbows should be used to form an angle as shallow as possible.
- 11 Connection to the appliance can either be direct using the Adaptor or a length of flue pipe can be connected to the Adaptor. In all cases, all joints between flue pipes/appliance outlets/chimney must be securely caulked and sealed with fibre rope (or suitable alternative) and fire cement. ANY flue pipe connection to the chimney MUST be made in the same room as the appliance.
- 12 The outlet of the chimney must comply with Building Regulations, where appropriate. Fig 6 indicates the requirements for solid fuel and oil served appliances. See IL Gas Vent Installation Instructions for Gas served appliance termination requirements.

Under most circumstances, the above regulations will permit the normal operation of the chimney. However, should it be necessary to construct the chimney so that it extends beyond 1.5 metres above the roof or last support, such extension must be provided with additional support. A Guy Wire Bracket should be clamped to the chimney for this purpose, to which rigid stays, preferably angle iron, should be connected.
- 13 The terminals illustrated are suitable for all fuels, with the exception of the Gas Vent Terminal. For such applications please refer to separate IL Gas Vent System Installation Instructions for details.
- 14 If painting of the chimney is desired, first thoroughly degrease and then dry and prime the surface; in the case of galvanised components, use a zinc chromate based primer. Apply a finishing coat of external quality paint as required. NB: Do not paint the chimney where it is internally positioned 50mm from combustible materials. SFL would suggest that a specialist is employed to undertake any painting of the product.
- 15 It is a regulatory requirement that a data plate is to be completed, positioned and secured by the installer where a hearth, fireplace, flue or chimney is provided or extended. The data plate provides essential information regarding the performance, specification, designation and installation for the chimney system. The data plate is to be completed by the installer using an indelible ink and securely fixed in an unobtrusive but obvious position.

It is strongly recommended that any galvanised components that are externally applied, are thoroughly protected by painting or suitable alternative.

Framing and Load Bearing Data

Table A: Framing Data

The following data provides the opening required in all floor and ceiling areas. All details in mm.

Chimney Size	127	152	178	203
External Diameter	175	203	230	255

Ventilated Firestop and Ventilated Ceiling Support

Framing Size*	281sq	301sq	331sq	351sq
---------------	-------	-------	-------	-------

* Includes plasterboard lining of the timber frame.

Table B: Load Bearing Data

The weight of the chimney can be borne in a number of ways and this table states the minimum length of chimney that can be supported by the various components. All details in metres.

Component	127	152	178	203	250	300	350
Ceiling Support	6	6	6	6	6	6	6
Vent Ceiling Support	6	6	6	6	6	6	6
Telescopic Floor Support	16.7	16.7	16.7	16.7	16.7	16.7	16.7
Roof Support*	9	9	9	9	9	9	9
Inspection Length	16.7	16.7	16.7	16.7	16.7	16.7	16.7
90°Tee	16.7	16.7	16.7	16.7	16.7	16.7	16.7
135°Tee	10.7	10.7	10.7	6.7	6.7	5.9	5.9

* Part of the chimney up to a maximum of 6m may be suspended beneath the roof support.

NB: Wall Bands are not load-bearing and must be used at intervals not exceeding 3.5m internally and 3.0m externally.

Wall Support Brackets

Diameter (mm)	Non-Inverted		Inverted	
	Closed	Open D>50	Closed	Open D>50
127	30	25	30	30
152	30	25	30	30
178	25	20	30	22
203	25	15	30	22
254	25	15	30	22
304	25	15	25	17
355	25	15	25	17

All details in metres.

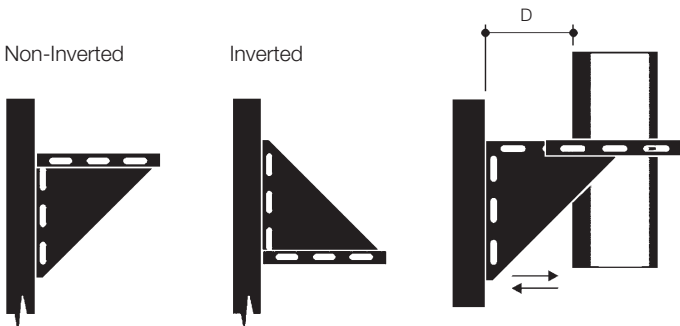

Chimney Termination

Fig. 6

The illustration and table identify the minimum requirements as dictated by Building Regulation where the chimney is used with solid fuel, wood or, if vapourising burner fitted, an oil-fired appliance.

A chimney terminal over a pressure jet oil-fired boiler must discharge a minimum 600mm above the roof penetration point, or any adjacent structure, if it is with 750mm. It must also be at least 600mm from any opening into the building and 300mm, from any combustible material. If the chimney extends more than 1.5m above last support, it must be supported with rigid stays.

See IL Gas Vent literature for details of legal termination requirements where SMW is used for gas fired appliances of rating up to 70kW.

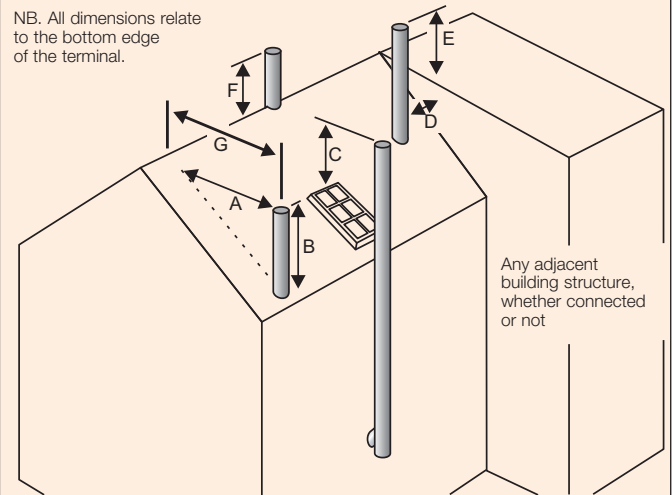

Dimension	Minimum distance measured from the top of the chimney construction, excluding any pot or terminal.
A	2.3 metres horizontally clear of the roof surface, eg. if the roof pitch is 45°, then the chimney should project 2.3 metres above it.
B	1 metre, provided A is satisfied, or 600mm above the ridge if G is less than 600mm.
C	1 metre above the top of any flat roof, and the top of any openable roof light, dormer window or ventilator, etc., if it is located within 2.3 metres.
D/E	If D is less than 2.3 metres, E shall be not less than 600mm.
F	600mm above the ridge.
G	Edge of chimney to roof ridge.

Kamin + Schornstein Vertrieb
 **Lemmermöhle**
www.edelstahl-schornsteine.com

Dörenther Str. 139b
48429 Rheine

Tel. 05971/807780
Fax. 05971/980929
free. 0800/52646984
mail. mail@edelstahl-schornsteine.com

The information contained in this brochure was accurate at the date of publishing. However the company reserves the right to introduce at any time modifications and changes of details as may be necessary. To avoid any misunderstanding, interested parties should contact the company to confirm whether any material alterations have been made since the date of this brochure.



FM557622



0086 - CPD - 496040

